

# SKM 195GB124DN



**SEMITRANS™ 2N**

## Low Loss IGBT Modules

**SKM 195GB124DN**

**SKM 195GAL124DN**

### Features

- N channel, homogeneous Silicon structure NPT-IGBT (Non punch-through)
- Low saturation voltage
- Low inductance case
- Low tail current with low temperature dependence
- High short circuit capability, self limiting to  $6 \times I_{cnom}$
- Fast & soft inverse CAL diodes
- Without hard mould
- Large clearance (10 mm) and creepage distance (20 mm)

### Typical Applications

- Switching (not for linear use)
- Switched mode power supplies
- DC servo and robot drives
- Inverters
- DC choppers
- AC motor speed control
- UPS Uninterruptable power supplies
- General power switching applications
- Electronic (also portable) welders

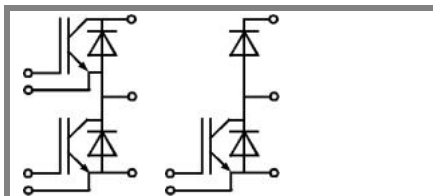

GB

GAL

Absolute Maximum Ratings		$T_c = 25\text{ °C}$ , unless otherwise specified	
Symbol	Conditions	Values	Units
<b>IGBT</b>			
$V_{CES}$		1200	V
$I_C$	$T_c = 25\text{ (80) °C}$	260 (180)	A
$I_{CRM}$	$T_c = 25\text{ (80) °C}$ , $t_p = 1\text{ ms}$	520 (360)	A
$V_{GES}$		$\pm 20$	V
$T_{vj}$ ( $T_{stg}$ )	$T_{OPERATION} \leq T_{stg}$	- 40 ... + 150 (125)	°C
$V_{isol}$	AC, 1 min.	2500	V
<b>Inverse diode</b>			
$I_F$	$T_c = 25\text{ (80) °C}$	200 (160)	A
$I_{FRM}$	$T_c = 25\text{ (80) °C}$ , $t_p = 1\text{ ms}$	520 (360)	A
$I_{FSM}$	$t_p = 10\text{ ms}$ ; sin.; $T_j = 150\text{ °C}$	1450	A

Characteristics		$T_c = 25\text{ °C}$ , unless otherwise specified			
Symbol	Conditions	min.	typ.	max.	Units
<b>IGBT</b>					
$V_{GE(th)}$	$V_{GE} = V_{CE}$ ; $I_C = 6\text{ mA}$	4,5	5,5	6,5	V
$I_{CES}$	$V_{GE} = 0$ , $V_{CE} = V_{CES}$ ; $T_j = 25\text{ (125) °C}$		0,2	0,6	mA
$V_{CE(TO)}$	$T_j = 25\text{ (125) °C}$		1,1 (1,1)	1,25 (1,25)	V
$r_{CE}$	$V_{GE} = 15\text{ V}$ ; $T_j = 25\text{ (125) °C}$		6,66 (8,66)	8 (10,66)	mΩ
$V_{CE(sat)}$	$I_C = 150\text{ A}$ , $V_{GE} = 15\text{ V}$ , chip level		2,1 (2,4)	2,45 (2,85)	V
$C_{ies}$	under following conditions		11	15	nF
$C_{oes}$	$V_{GE} = 0$ , $V_{CE} = 25\text{ V}$ , $f = 1\text{ MHz}$		1,6	2	nF
$C_{res}$			0,8	1	nF
$L_{CE}$				25	nH
$R_{CC'+EE'}$	res., terminal-chip $T_c = 25\text{ (125) °C}$		0,75 (1)		mΩ
$t_{d(on)}$	$V_{CC} = 600\text{ V}$ , $I_C = 150\text{ A}$		70		ns
$t_r$	$R_{Gon} = R_{Goff} = 7\text{ Ω}$ , $T_j = 125\text{ °C}$		55		ns
$t_{d(off)}$	$V_{GE} = \pm 15\text{ V}$		490		ns
$t_f$			65		ns
$E_{on} (E_{off})$			26 (23)		mJ
<b>Inverse diode</b>					
$V_F = V_{EC}$	$I_F = 150\text{ A}$ ; $V_{GE} = 0\text{ V}$ ; $T_j = 25\text{ (125) °C}$		2 (1,8)	2,5	V
$V_{(TO)}$	$T_j = 125\text{ ( ) °C}$		1,1	1,2	V
$r_T$	$T_j = 125\text{ ( ) °C}$			7	mΩ
$I_{RRM}$	$I_F = 150\text{ A}$ ; $T_j = 125\text{ ( ) °C}$		87		A
$Q_{rr}$	$di/dt = 1500\text{ A/μs}$		19		μC
$E_{rr}$	$V_{GE} = V$				mJ
<b>FWD</b>					
$V_F = V_{EC}$	$I_F = 150\text{ A}$ ; $V_{GE} = 0\text{ V}$ ; $T_j = 25\text{ (125) °C}$		2 (1,8)		V
$V_{(TO)}$	$T_j = 125\text{ ( ) °C}$		1,1	1,2	V
$r_T$	$T_j = 125\text{ ( ) °C}$			7	mΩ
$I_{RRM}$	$I_F = 150\text{ A}$ ; $T_j = 125\text{ ( ) °C}$		87		A
$Q_{rr}$	$di/dt = 0\text{ A/μs}$		19		μC
$E_{rr}$	$V_{GE} = V$				mJ
<b>Thermal characteristics</b>					
$R_{th(j-c)}$	per IGBT			0,12	K/W
$R_{th(j-c)D}$	per Inverse Diode			0,23	K/W
$R_{th(c-s)}$	per module			0,05	K/W
<b>Mechanical data</b>					
$M_s$	to heatsink M6	3		5	Nm
$M_t$	to terminals M5	2,5		5	Nm
w				160	g

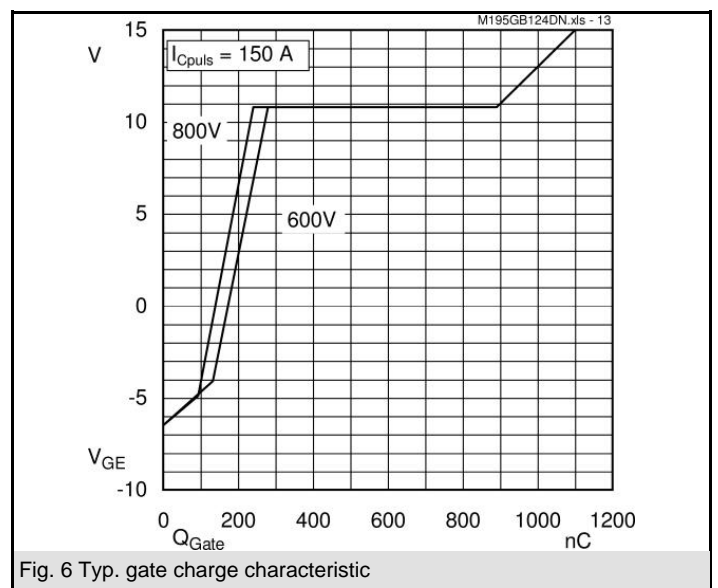
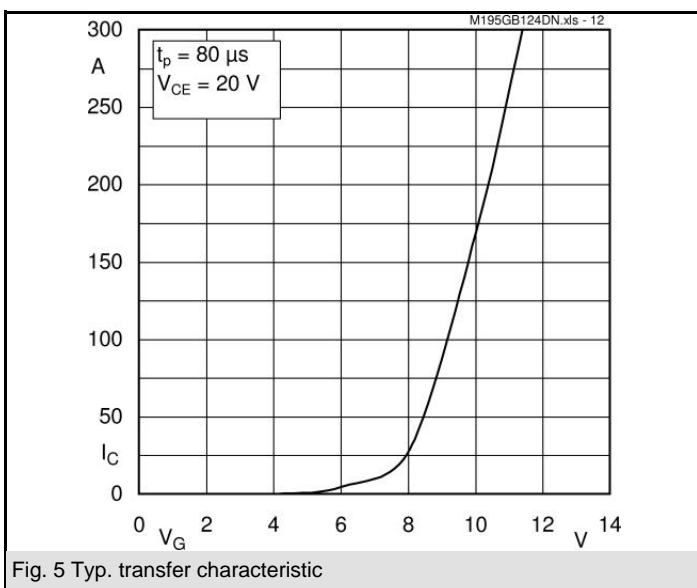
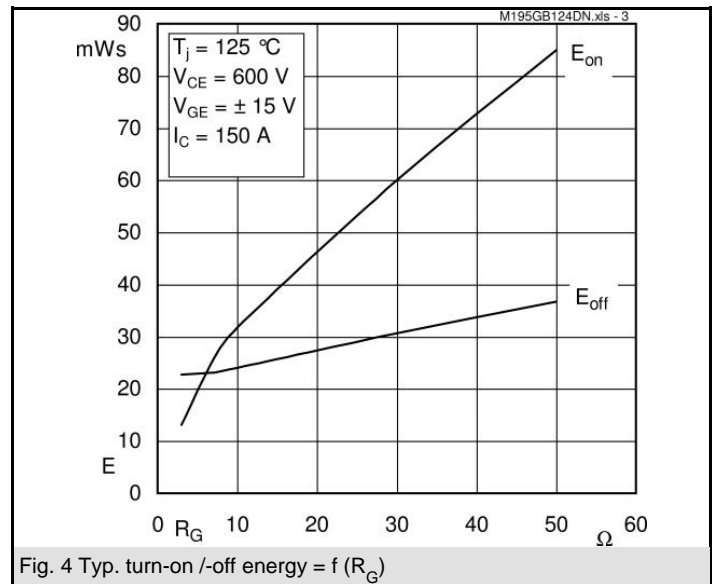
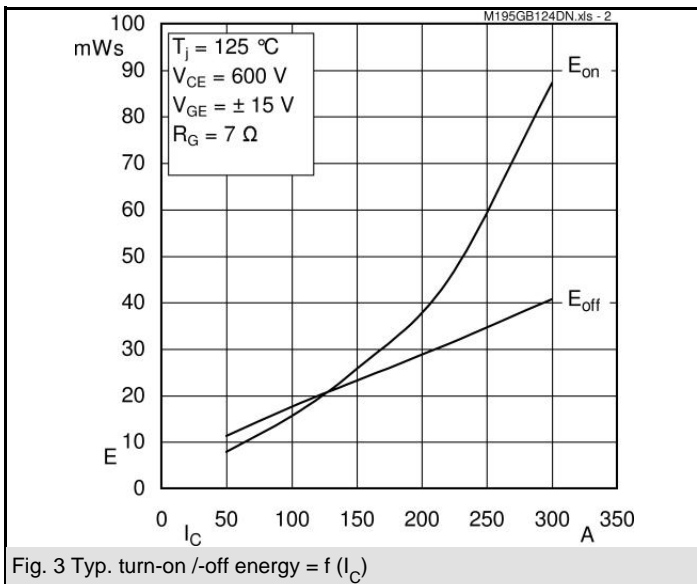
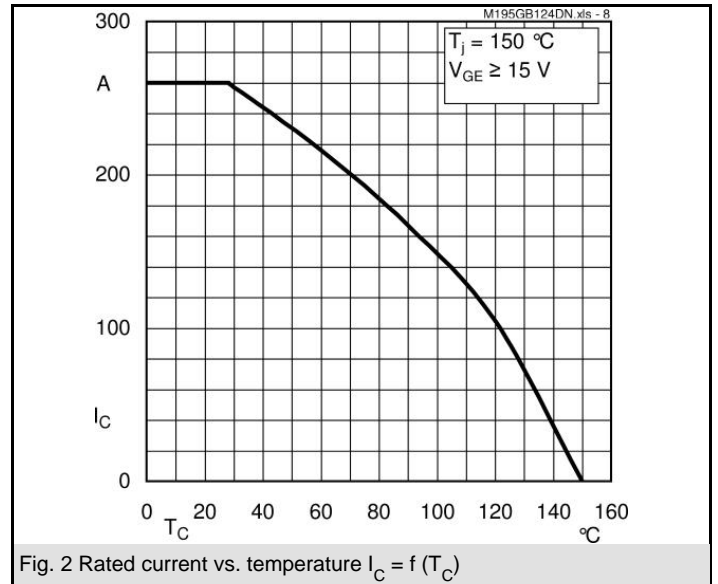
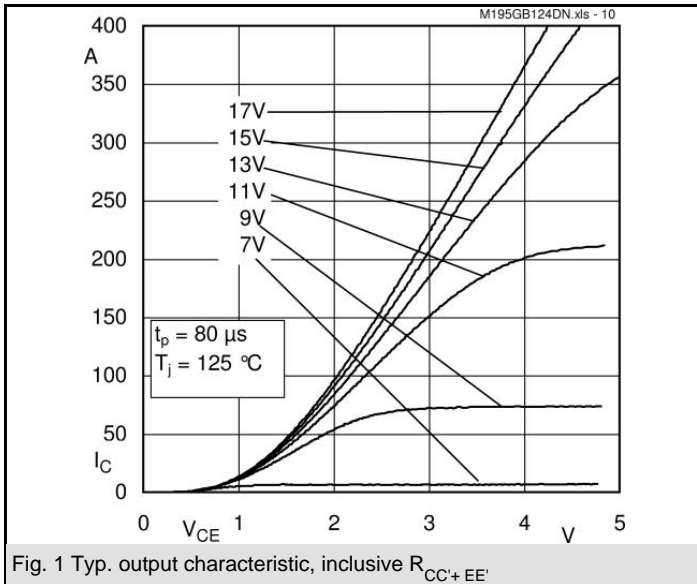

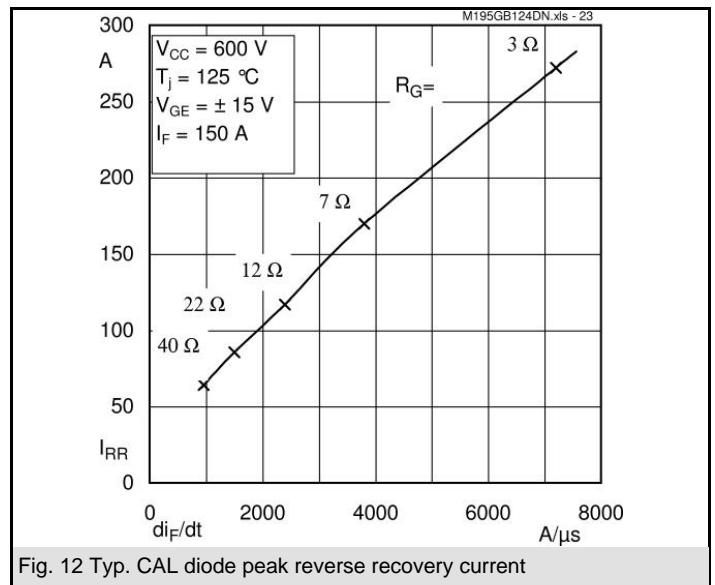
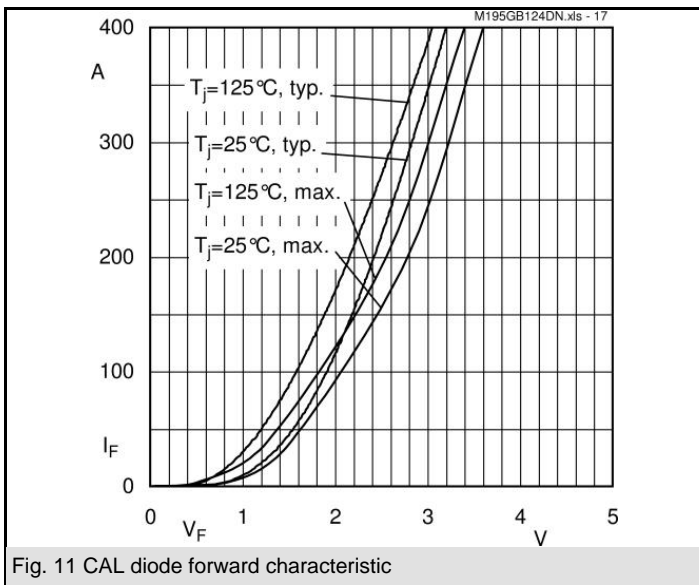
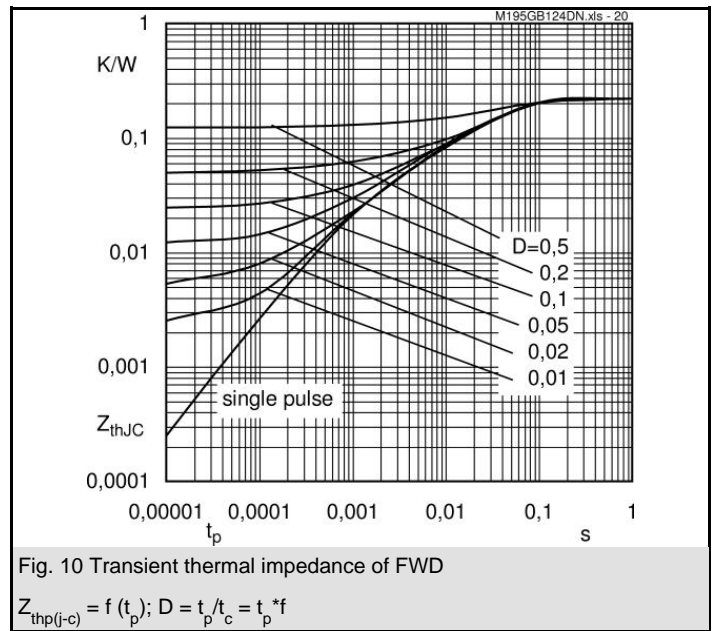
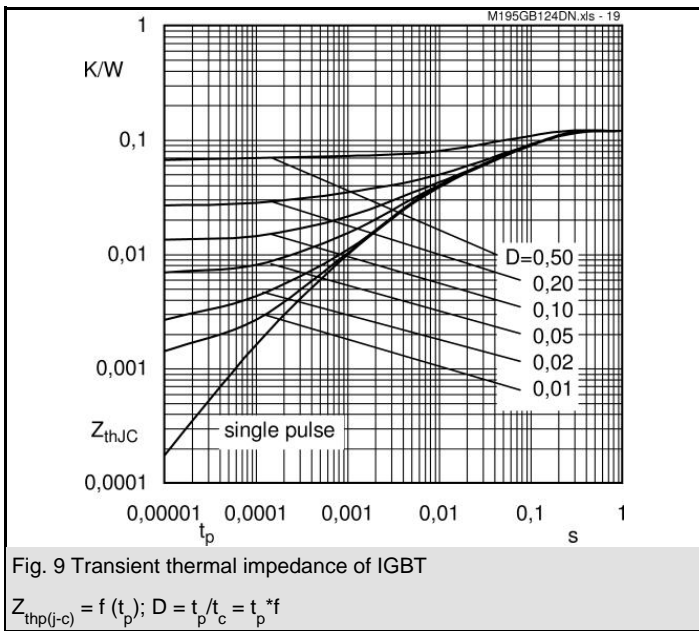
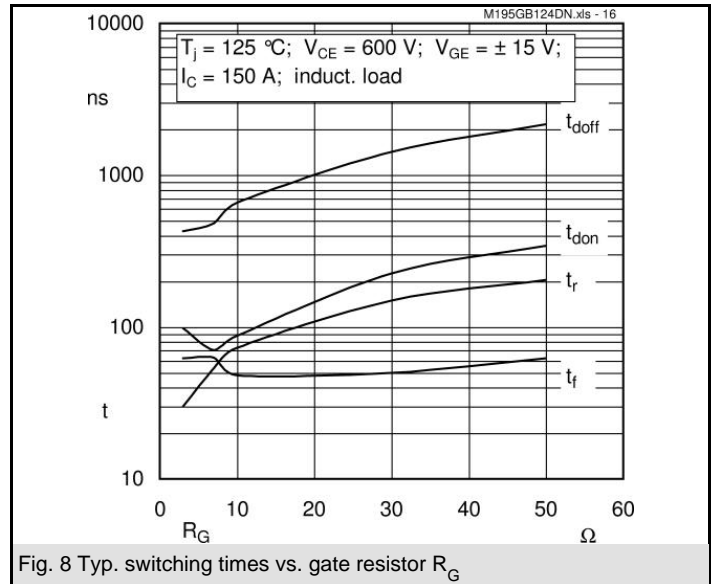
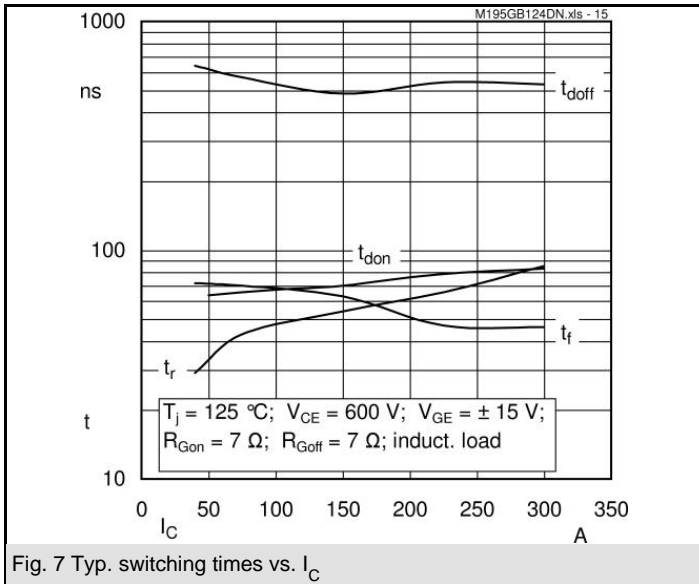

# SKM 195GB124DN

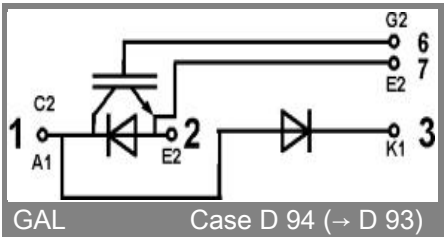
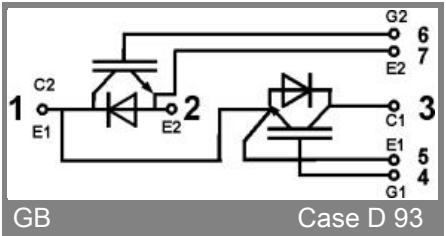
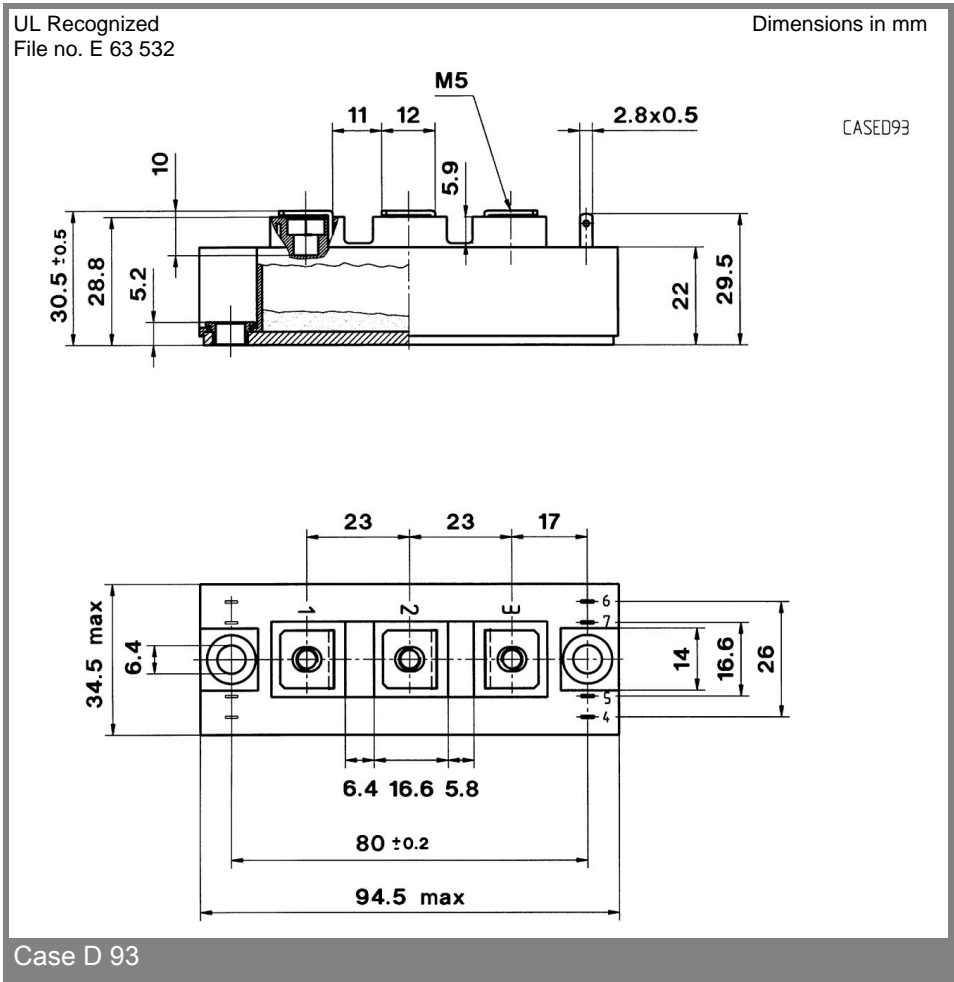
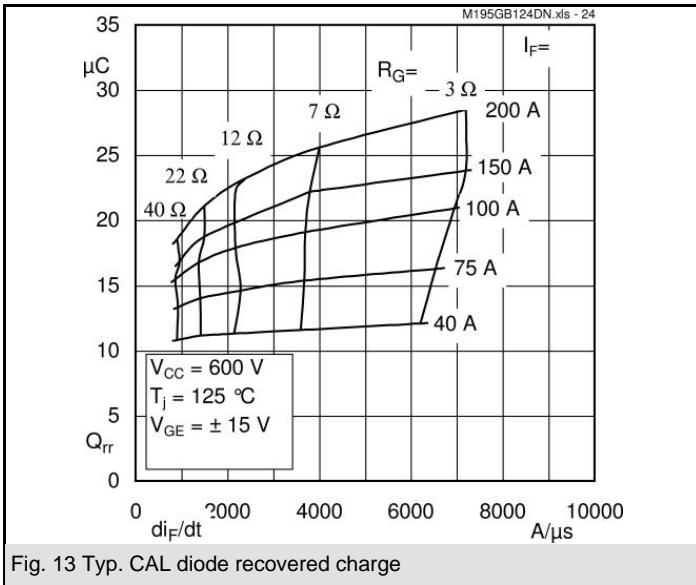

This is an electrostatic discharge sensitive device (ESDS), international standard IEC 60747-1, Chapter IX.

This technical information specifies semiconductor devices but promises no characteristics. No warranty or guarantee expressed or implied is made regarding delivery, performance or suitability.

**This datasheet has been downloaded from:**

**[www.EEworld.com.cn](http://www.EEworld.com.cn)**

**Free Download**

**Daily Updated Database**

**100% Free Datasheet Search Site**

**100% Free IC Replacement Search Site**

**Convenient Electronic Dictionary**

**Fast Search System**

**[www.EEworld.com.cn](http://www.EEworld.com.cn)**